

The following study was conducted by Roger Applewhite, an electrical engineer, and was published in 2005: Applewhite R. “The effectiveness of a conductive patch and a conductive bed pad in reducing induced human body voltage via the application of earth ground.” *European Biology and Bioelectromagnetics* 2005; 1: 23–40

The Effectiveness of a Conductive Patch and a Conductive Bed Pad in Reducing Induced Human Body Voltage Via the Application of Earth Ground

April 29, 2004

Roger Applewhite, P.E.
Static Prevention, Inc.

Abstract

Voltage induced on a human body by capacitive coupling to the external environment was measured using a high-impedance measurement head. The body was then earth grounded by means of a Conductive Patch and a Conductive Bed Pad. Each method reduced the coupled 60Hz mains voltage by a factor of at least 70. This result, along with the measurement of the voltage drop across an in-line resistance in the Conductive Patch provided evidence of a simplified electrical network model of the human body.

Table of Contents

<i>Abstract</i>	- 1 -
<i>Table of Contents</i>	- 2 -
<i>Introduction</i>	- 3 -
<i>Test Model</i>	- 3 -
<i>Test Setup</i>	- 5 -
Instrumentation	- 6 -
Test Environment Geometry	- 9 -
<i>Test Method</i>	- 11 -
<i>Results</i>	- 11 -
<i>Conclusion</i>	- 15 -
<i>Appendix</i>	<i>Error! Bookmark not defined.</i>
FFT Screen Data	- 16 -
Instrumentation List	- 20 -

Introduction

The human body exists in an environment filled with electromagnetic fields. Since the body has conductive elements, these fields can induce currents and voltages. In recent years, there has been much interest in both the scientific and lay communities of the possible biophysical effects of these electrical inductions. Many now believe that human health can be compromised by electromagnetic fields under certain conditions.

Research is now underway in the biomedical community to quantify the health effect. In parallel with that effort, other parties are developing engineered methods of mitigating the induced voltages and currents. As the connection between physical ailments and electromagnetic fields are established, efficacious methods of treating and/or preventing these ailments via induction mitigation will become available.

This study is concerned with the effectiveness of two such methods of electromagnetic field mitigation on the human body. It focuses in particular on the reduction of body surface voltage by bringing the skin to the earth's electrical potential by either conduction or significant capacitive coupling. This study does not investigate the reduction of induced currents, nor does it study the effect of body surface voltage on health.

Test Model

Environmentally induced voltage on the human body arises due to a variety of phenomenon. These can be broadly classified depending on the time dependent nature of the voltage. If the voltage changes are at a rate that is on the order of seconds or minutes, it is termed *static*. If it changes at a faster rate, it is termed *dynamic* or *AC*. This study focuses specifically on the latter, or *AC* voltage.

Generally speaking, if an object is not conductively connected to an *AC* voltage source such as a power outlet, any *AC* voltages induced on it occur due to capacitive coupling between an *AC* electromagnetic source (such as a mains wire) and the object. The alternating electric field of the source induces a voltage on the object. The reference for this voltage is the same as the voltage reference of the source.

The amount of induced voltage on the object depends not only on the voltage of the *AC* source and the magnitude of the capacitive link between it and the object, but on the capacitive link between the object and the *AC* source's voltage reference. Normally, the earth's potential is used as this reference, and we use it in this study as well.

If we specify the human body as the object, then the strength of the *AC* source, along with the magnitude of the capacitive links to the *AC* source and the earth, determine the voltage induced on the body. A simplified electrical network can be used to represent this model:

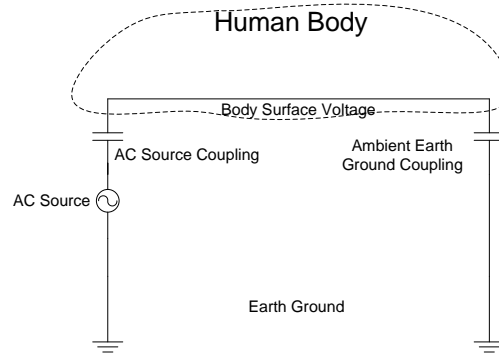

Figure 1, *Electrical Network Model of the Human Body*

In reality, the electrical behavior of the body and its interaction with electromagnetic fields in the environment is substantially more complex, and includes other elements such as resistance and inductance. However, for the purposes of this study, this model is useful in understanding the effect of earth grounding the human body, and is widely accepted as a reasonable approximation of a real body’s electrical response, as long as the spectral content of interest is not of too high a frequency.

The amount of capacitance of the human body relative to the earth is generally regarded to be 100pF^1 for large voltages and is the value assumed for modeling purposes here. The capacitance to common AC sources, such as mains wires, is highly dependent on the geometry of a particular situation and the presence of conductors. Anecdotal measurements of body voltages have yielded results from 0 to 4 volts RMS. Using impedance analysis of the network in figure 1, the capacitance of the AC source to the human body can be estimated to be on the order of 1 pF^2 .

Earth grounding the human body can be accomplished either through a conductive connection from the body or via a significant capacitive coupling. This can be represented in the network model as follows:

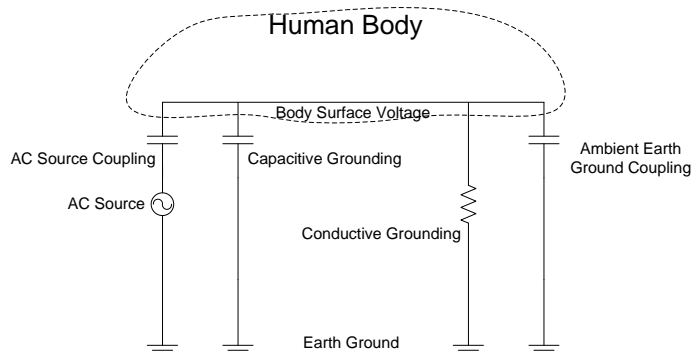

Figure 2, *Electrical Network Model of the Human Body Grounded*

¹ “An Investigation of Human Body Electrostatic Discharge,” M.A. Kelly, G.E. Servais and T.V. Pfaffenbach, ISFTA, 1993

² Voltage ratio for a sinusoidal input is $C1/(C1+C2)$, where $C1$ is the AC source coupling and $C2$ is the ambient earth ground coupling.

Again, impedance analysis can be used to determine the resulting body voltage due to this grounding. Due to the very small capacitances of the “AC Source – Human Body” coupling and the “Human Body – Earth Ground” coupling, the impedance of either grounding method does not have to be particularly low to achieve a theoretical reduction of body voltage of a significant amount. This study tests the practical manifestation of each of these grounding methods, the Conductive Patch and the Conductive Bed Pad respectively, and establishes whether they provide effective body voltage reduction.



Figure 3, Conductive Patch



Figure 4, Conductive Bed Pad Test Setup

Instrumentation

The goal of the instrumentation design was to accurately detect body surface voltage without bias or unwanted interaction with the test environment. As the body voltage of interest is AC, the spectral content of the body voltage provides the most complete picture of the voltage. Therefore, a Tektronix TDS220 oscilloscope with FFT module was employed.

The electrical network model of the human body described previously illustrates some of the difficulties encountered when trying to measure body voltage induced by AC sources:

1. **Measurement Impedance** – As noted, impedance analysis suggests that it does not require a significant amount of conductivity to the earth to reduce body voltage. Unfortunately, the measuring device used in this study, the Tektronix TDS200 oscilloscope, has some small conductivity to earth. Enough, in theory, to significantly reduce body voltage itself. Obviously, this would result in a contamination of the data.
2. **Measurement Reference** – The oscilloscope displays voltages in reference to a certain ground, namely that provided by the 3d prong of a power outlet. Generally speaking, this prong is connected to earth ground at the point the mains power enters the building where the outlet is located. However, due to non-zero resistance in practice, and coupling to the mains hot lead, 3d prong ground can have a voltage that is different than the earth. This could introduce a reference bias.
3. **Measurement Capacitive Coupling** – The probe used with the oscilloscope can also be capacitively coupled to the AC source, resulting in voltages on the probe that are not the body voltage.
4. **Common Mode Error Due to Static Voltage on the Body** – The static voltage of the body, which is not being measured in this study, can alter the measurement of the AC voltage of the body if it is large enough. In many circumstances, the ratio of static to AC can be 1000 or more, causing measurement errors.

To combat these problems, instrumentation for the test was designed as follows:

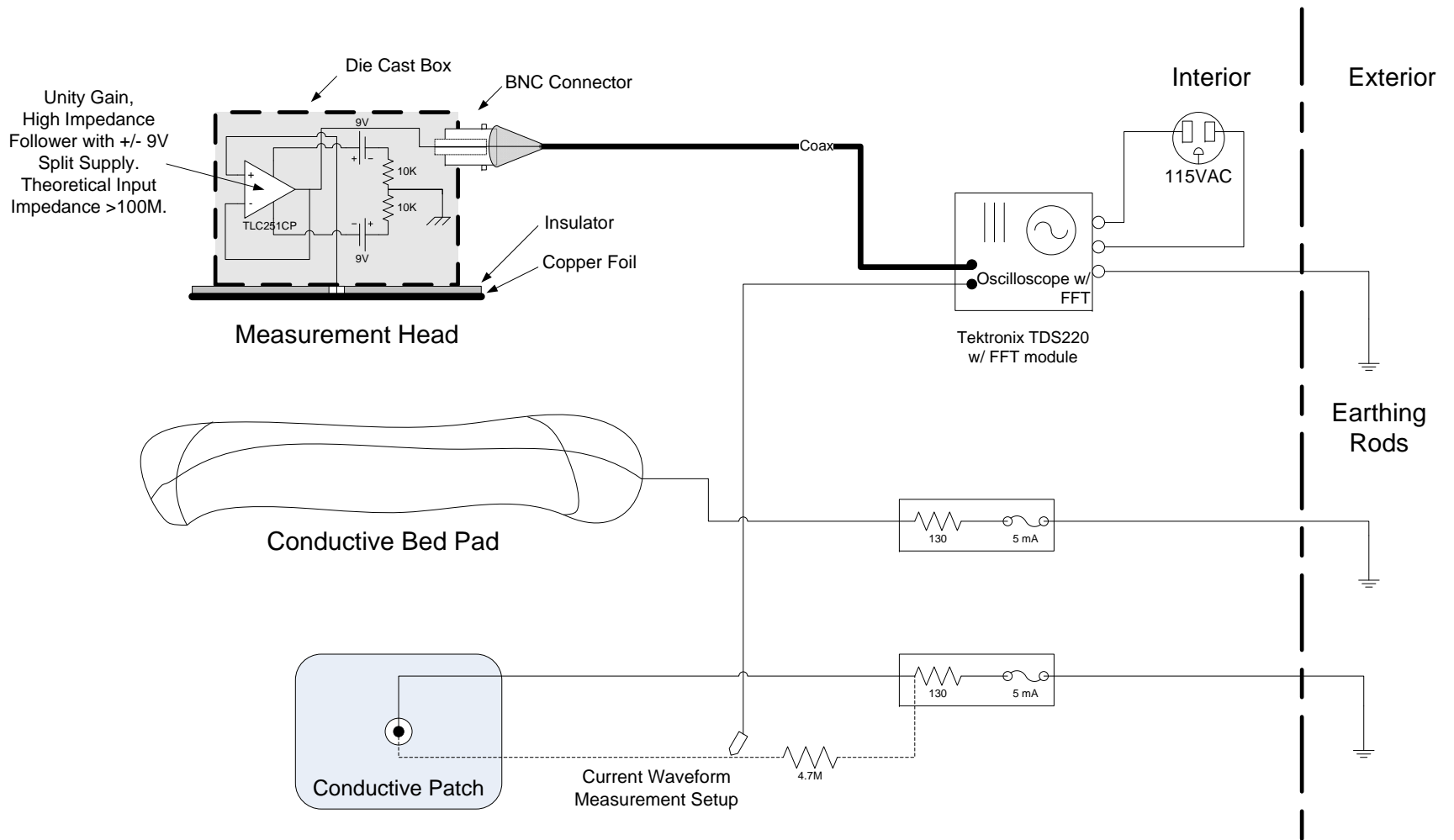

Figure 5, Body Voltage Instrumentation

The input impedance of the body voltage measurement head (Figure 6) is well in excess of 100 MegOhms. This should not alter the body voltage in a measurable way, as given by the impedance analysis of the network model. The dynamic range of the head unit is about 15 volts peak-to-peak, which is comfortably larger than the body voltages anecdotally reported. In addition, the head unit is completely enclosed in conductive steel, which continues the shielding path of the coaxial cable that connects it to the oscilloscope, and helps to shield the measurement head from stray capacitance. Finally, the head unit has a significant common mode rejection ratio (>60dB) and the test subject is earth grounded before each measurement to drain any parasitic static voltage.

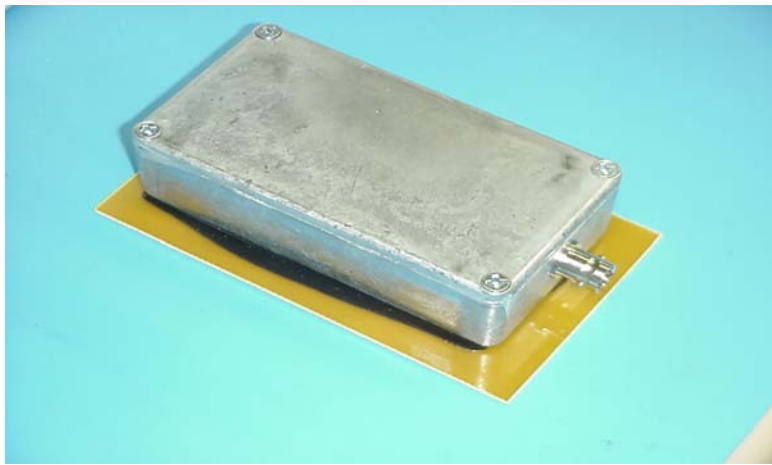

Figure 6, Measurement Head

The oscilloscope 3d prong was not connected to the power outlet, but rather to a grounding rod similar to that used by the Conductive Patch and Conductive Bed Pad. This made the ground references consistent.

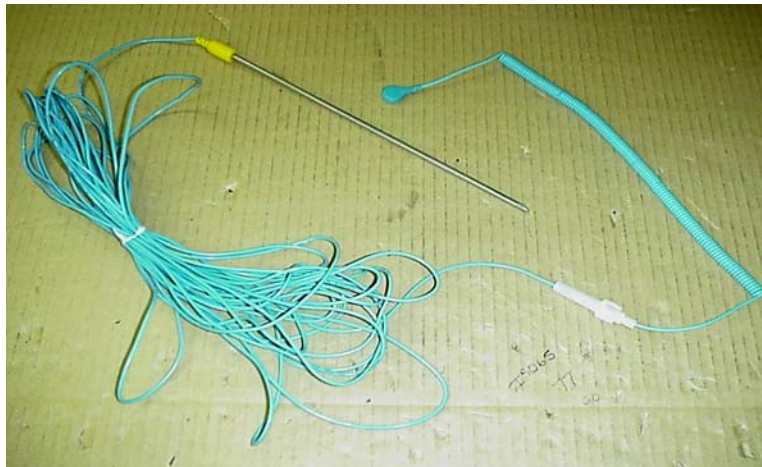

Figure 7, Ground Rod Assembly

Test Environment Geometry

The test environment was laid out as shown in figure 8. Earth ground was connected via a steel rod inserted into moist soil to a depth of 11". The resistance measured between the rods was 1 – 3 KOhms. This amount is small compared to the impedances of the capacitive coupling being investigated.

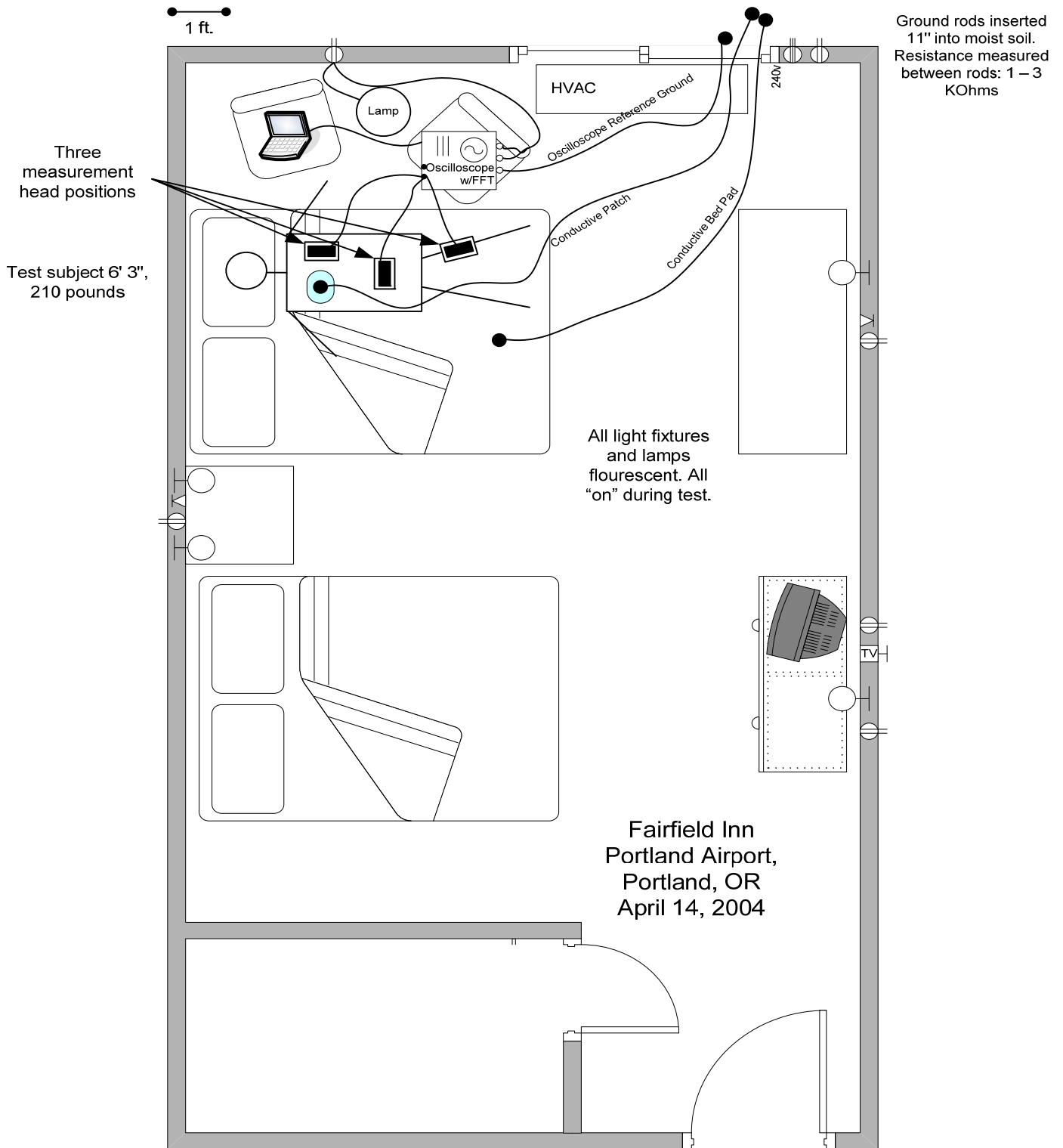

Figure 8, Test Geometry

Test Method

The test was conducted on April 14, 2004 at the Fairfield Inn Portland Airport, Portland, OR.

The test subject (the author) remained prostrate on a bed while the measurement head was placed in one of three positions for measurement: left breast, abdomen, left thigh. Several measurements were taken until consistent results were found. In particular, it was discovered that body hair contacting the steel enclosure of the head unit provided enough conductivity to ground to substantially reduce body voltage. Great care was exercised to avoid this condition. Contact between the head unit and the skin was aided only by the weight of the unit, at about 1 pound.

The Conductive Patch, when tested, was applied underneath the right breast. The Conductive Bed Pad, when tested, was placed directly on the mattress, and then a thin top sheet placed over it before the subject laid on it. The coupling to the body, therefore, was assumed to be capacitive only.

A baseline FFT spectrum was recorded for each head position, and then the Conductive Patch and Conductive Bed Pad were tested in turn. The data was transmitted to a laptop computer via RS232 connection and stored. The FFT used a flattop window for amplitude accuracy and acquired 1024 points of the waveform to compute the transform from 0 to 500Hz. The Oscilloscope was AC coupled to the measurement head.

Results

The baseline result for the three measurement head locations is shown in figure 9. The five most significant spectral modes were extracted. The remaining spectrum was less than -40 dB (0 dB = 1 Volt RMS), and therefore considered to be the noise floor. The dominant mode is at 60 Hz as expected. This mode is assumed to be the capacitively coupled effect of mains voltage on the body as described earlier in the document. The source of the remaining modes is unknown (other than 180Hz, an overtone of 60Hz), though none were greater than -25 dB. The position of the measurement head on the body had only a notional effect on the magnitude of the modes. As a check, the time domain waveform was also examined and visually measured for average amplitude. Converting this to RMS (assuming a sinusoidal crest factor) yielded a very similar result to the 60Hz mode on the spectrum analysis.

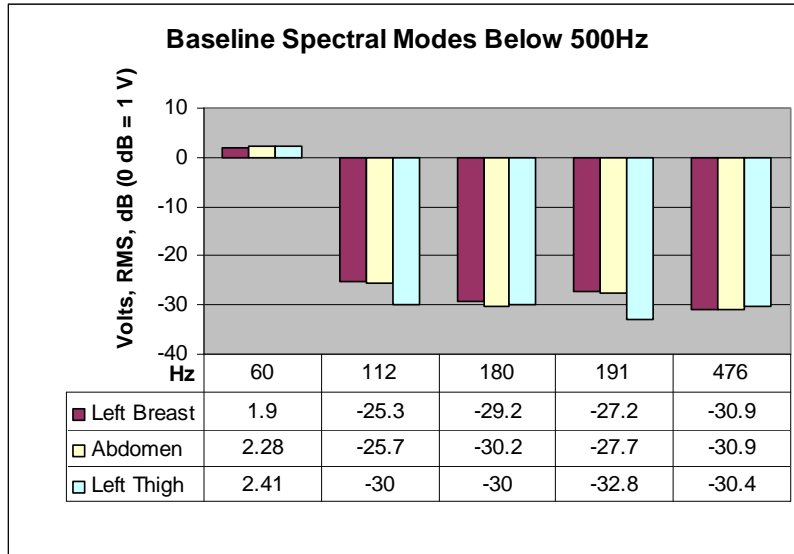

Figure 9

Next, the Conductive Patch was applied. The results are shown in figure 10 along with a 60Hz baseline comparison in figure 11. The reduction of the 60Hz mode to essentially the noise floor is consistent with the model of body grounding presented. The remaining modes were affected in a less dramatic fashion, with some even increasing in amplitude. There are many possible explanations for this, including electric fields generated by the body itself and not the environment, the noise rejection capability of the instrumentation setup (as these modes are still in the vicinity of the noise floor), or the impedance of the Conductive Patch. However, it is clear that the Conductive Patch reduced the 60Hz mode by a factor of about 70.

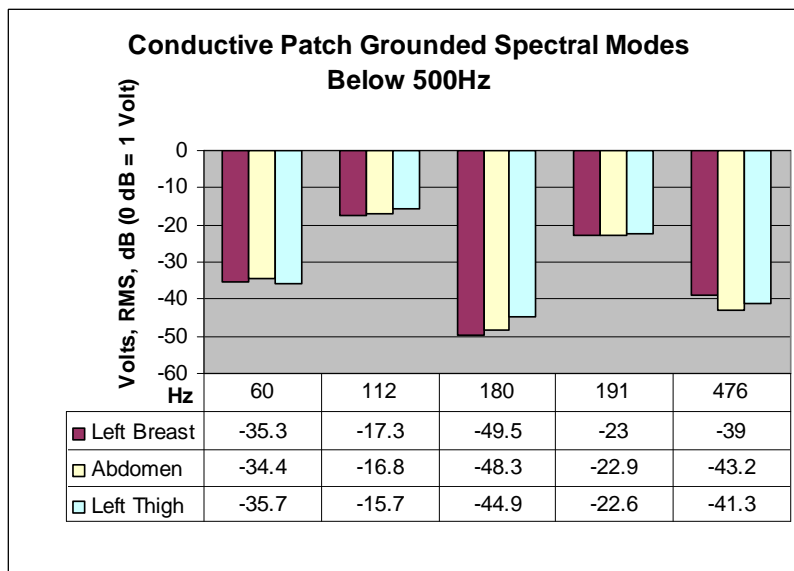

Figure 10

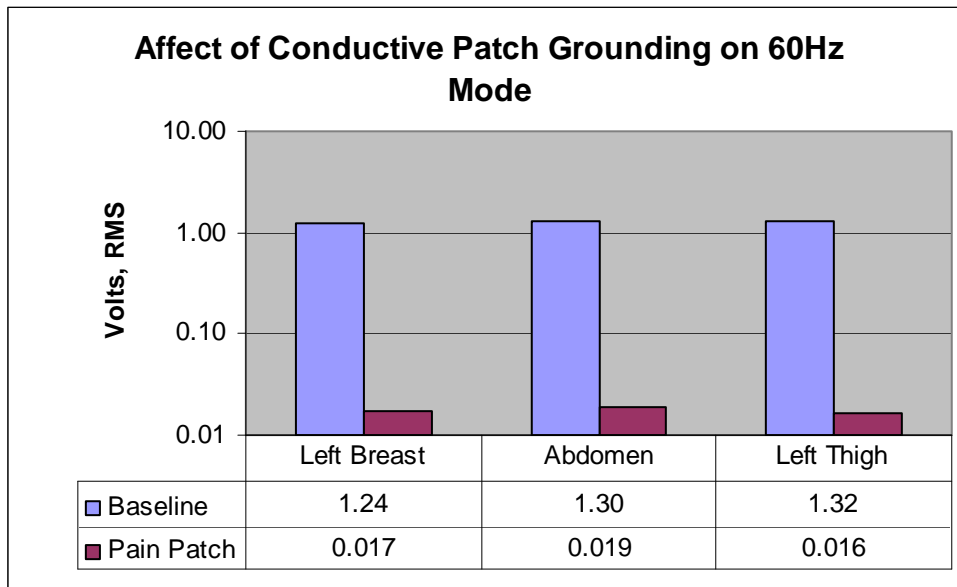

Figure 11

The Conductive Bed Pad produced very similar results, as shown in figures 12 and 13. The reduction factor increased to about 110.

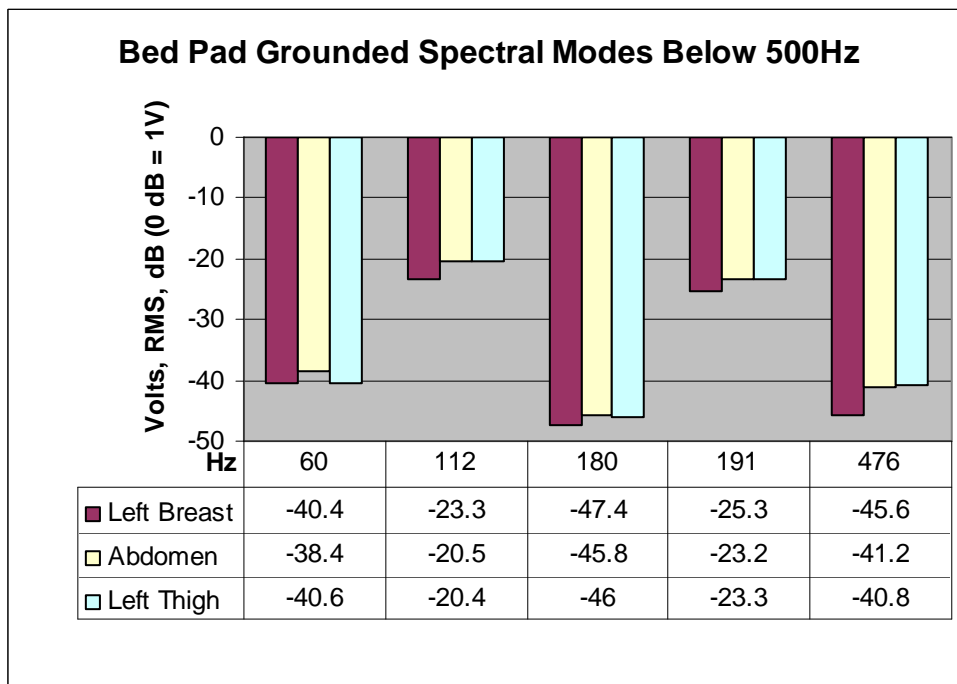

Figure 12

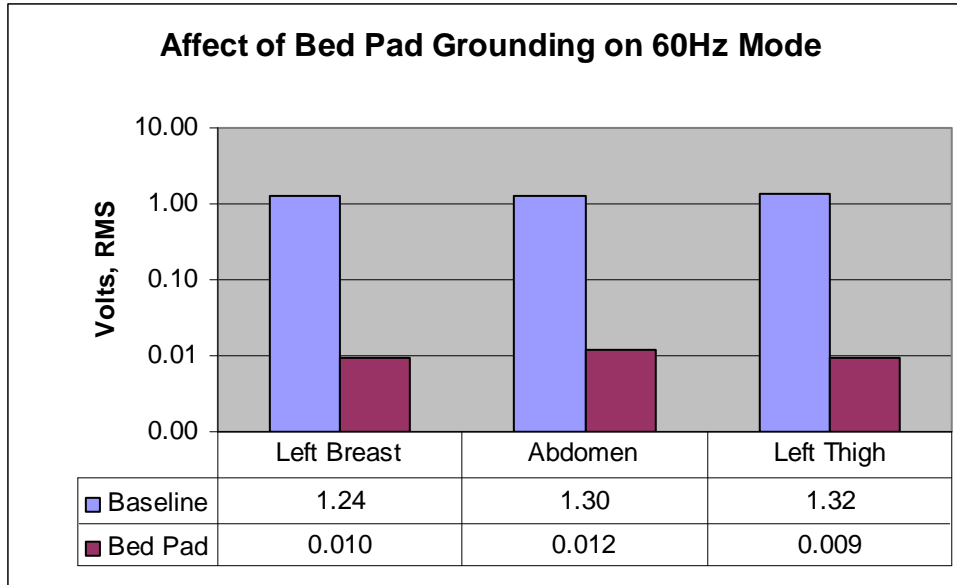

Figure 13

As a final check of the network model, a probe was attached to the connection of the Conductive Patch as shown in figure 5, and the measurement head was placed on the left palm of the test subject. The purpose of this was to verify a voltage drop across the impedance to earth ground that represented the current into the body's capacitance as a result of the 60Hz electric field induction. In order to yield a voltage that clearly stood above the noise, a very large resistor (4.7M) was placed in line of the Conductive Patch. Along with the oscilloscope, this produced a total resistance addition of 820KOhm.

Figure 14 shows the ungrounded body voltage (labeled 3), the grounded body voltage described above (labeled 5) and the voltage drop across the impedance (labeled 2). As can be seen, body voltage is reduced, even through a relatively high impedance. This is consistent with our estimate of the small capacitive link between mains voltage and the body. In addition, the voltage drop waveform is of primarily the same shape as the original body voltage. The waveforms were moved along the time axis so as to make their peaks coincide, as a phase shift would be expected from impedance analysis. This is consistent with the current we expect to be entering the body capacitance from earth ground.

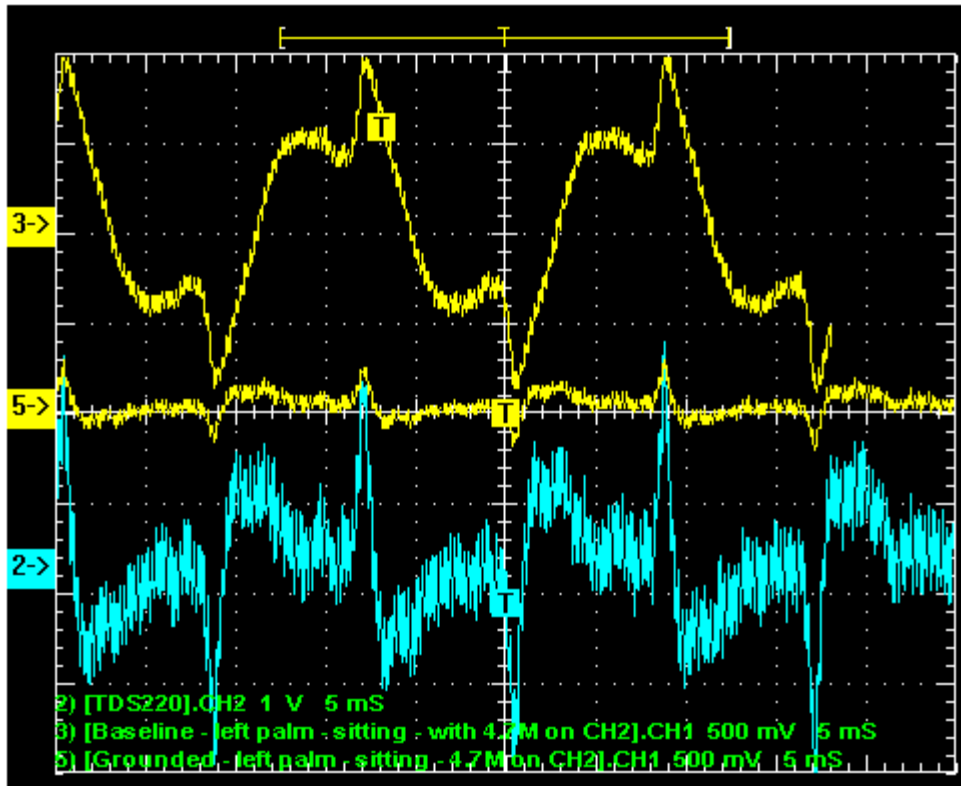

Figure 14, Current Through an Earth Grounding Connection

Conclusion

The testing performed confirms that the Conductive Patch and the Conductive Bed Pad are both effective in reducing the mains induced body voltage by a considerable amount. The test also provided evidence that the electric network model of the body used in this study generally explains the phenomenon demonstrated in the test.

Appendix

FFT Screen Data

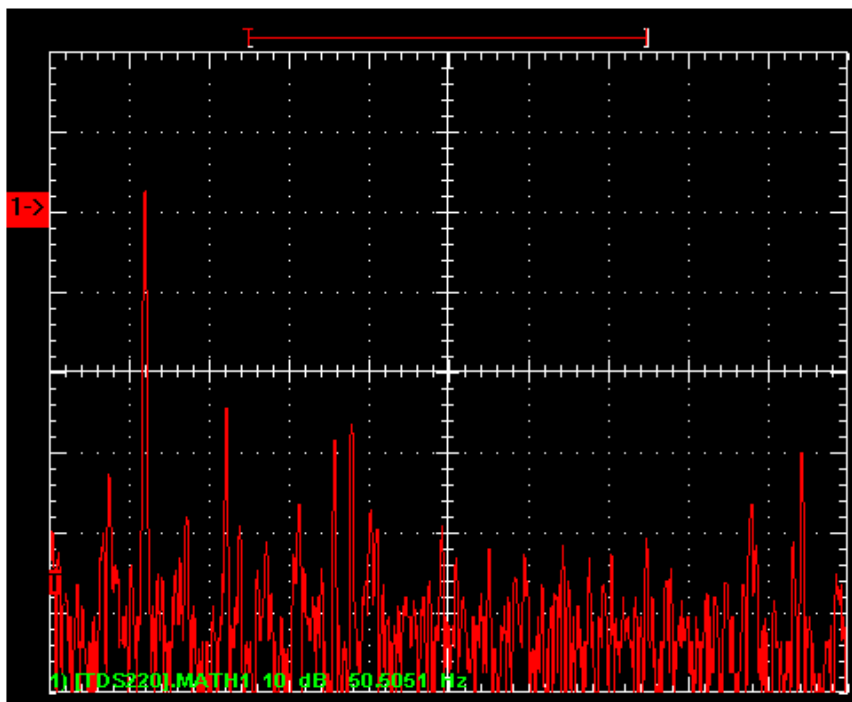

Figure 15, Baseline FFT, Left Breast

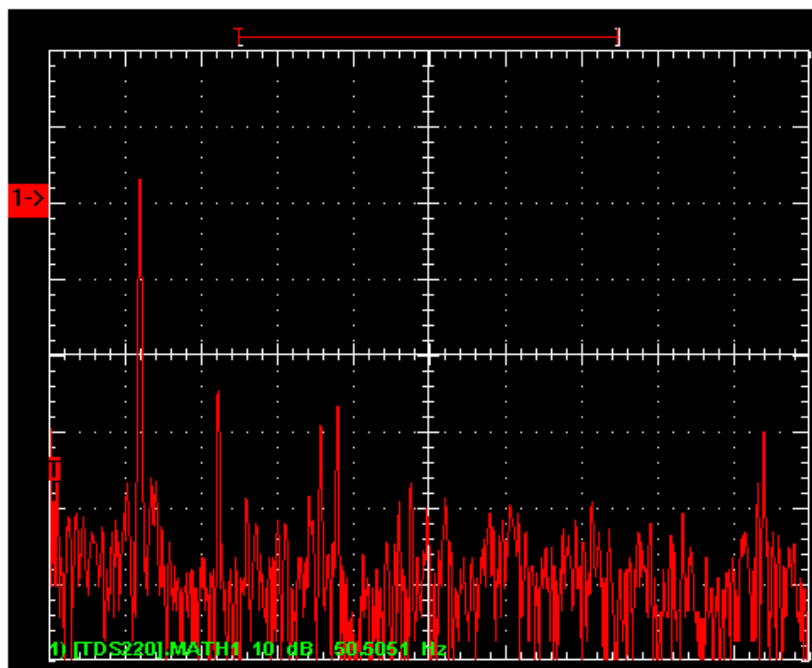

Figure 16, Baseline FFT, Abdomen

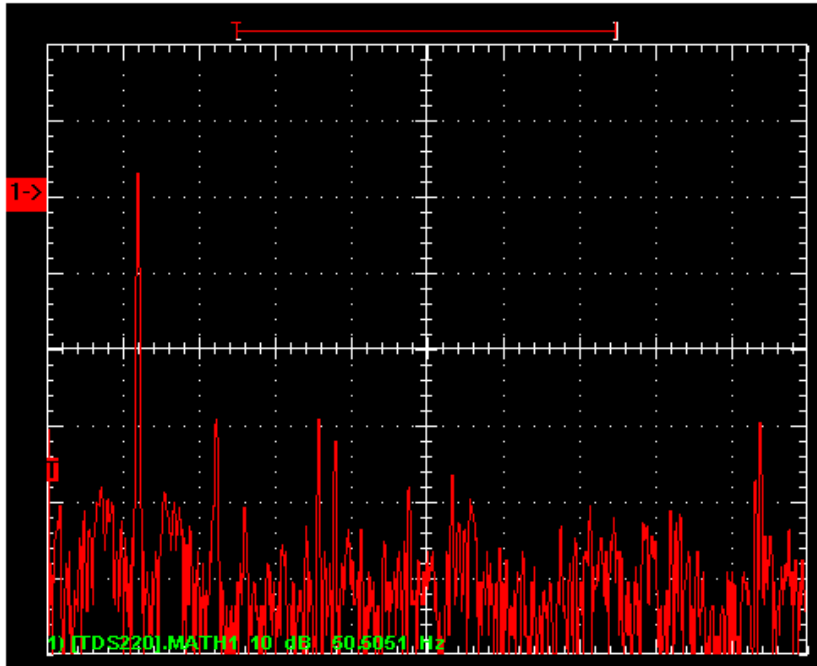

Figure 17, Baseline FFT, Left Thigh

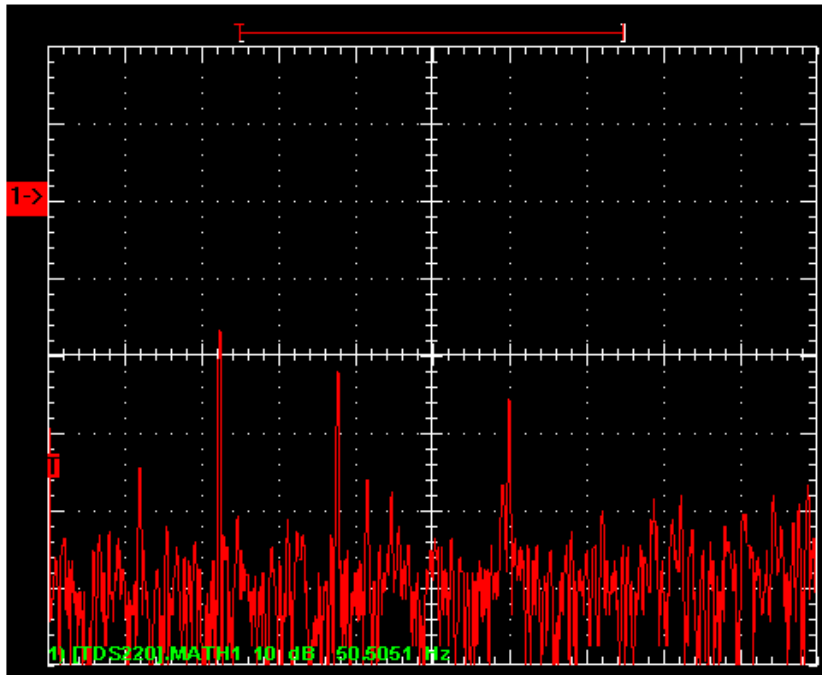

Figure 18, Conductive Patch Grounded FFT, Left Breast

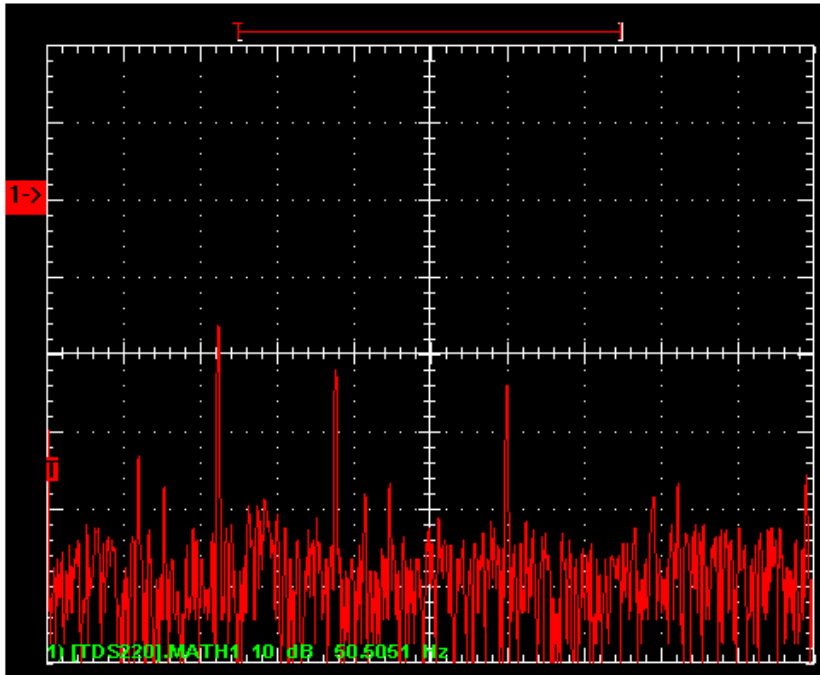

Figure 19, Conductive Patch Grounded FFT, Abdomen

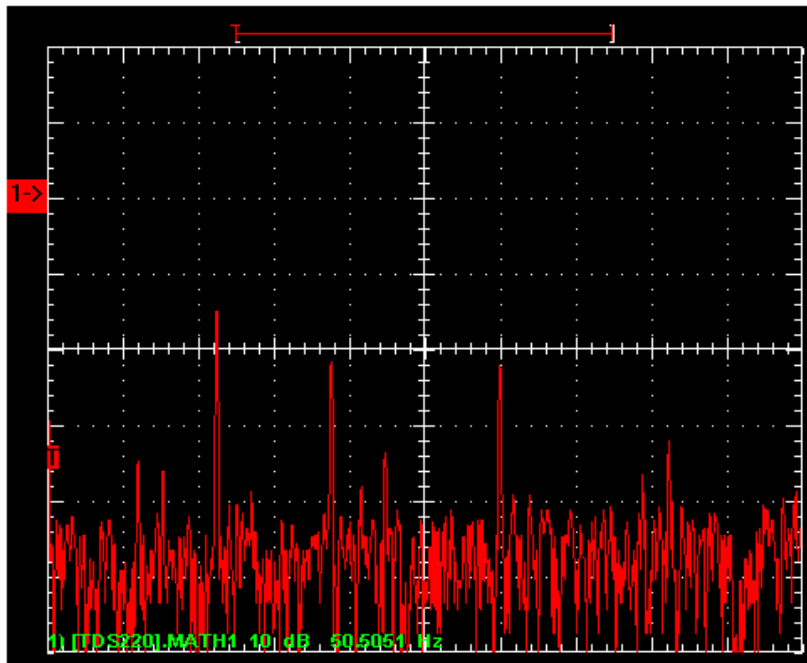

Figure 20, Conductive Patch Grounded FFT, Left Thigh

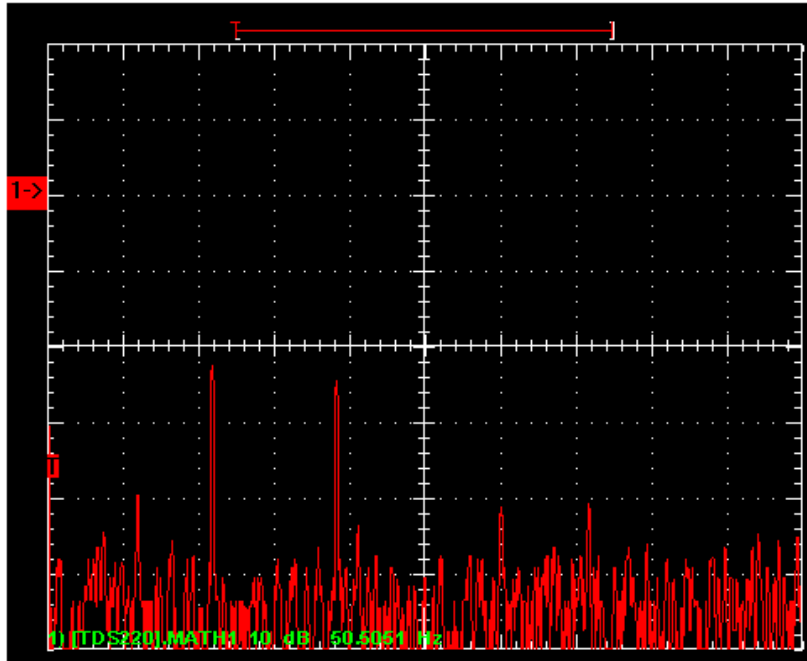

Figure 21, Conductive Bed Pad Grounded FFT, Left Breast

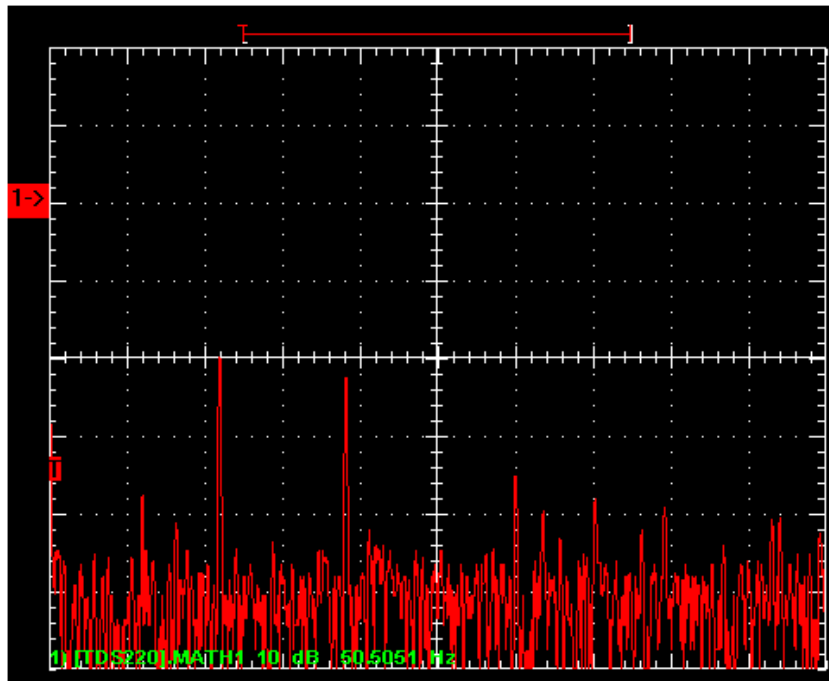

Figure 22, Conductive Bed Pad Grounded FFT, Abdomen

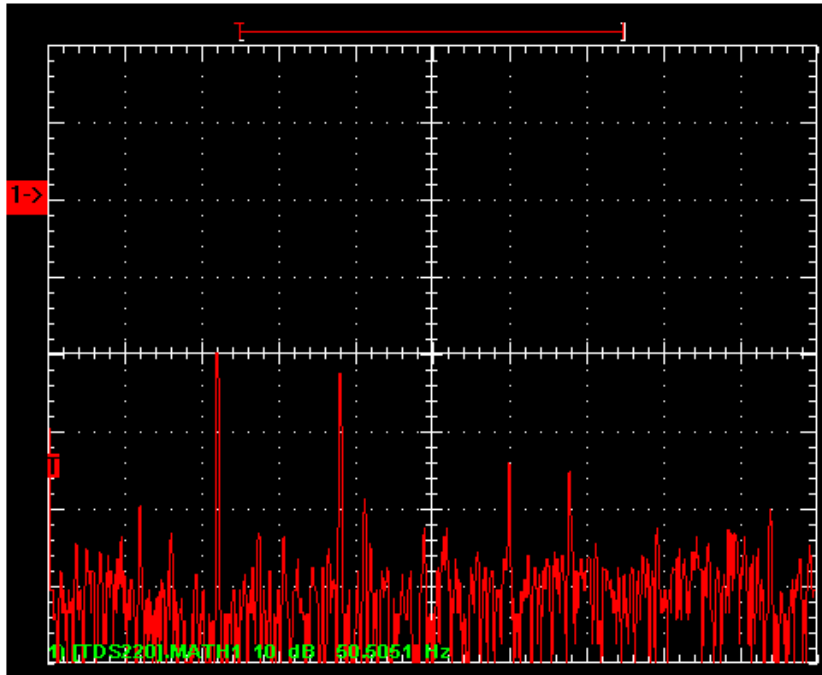

Figure 23, Conductive Bed Pad Grounded FFT, Left Thigh

Instrumentation List

Tektronix TDS 220 Two Channel Digital Real-Time Oscilloscope with TDS2MM Measurement Module

- Bandwidth: 60 MHz
- Maximum Sample Rate: 1 GS/s
- Last Calibrated: March 31, 2004

Pomona Electronics Model 6266 Oscilloscope Probe, 60MHz

Tektronix WaveStar v. 2.6

Texas Instruments TLC251CP LinCMOS™ Programmable Low-Power Operational Amplifier

- +/- 9 Volt split supply
- High Bias mode selected